



2020-2021

PRODUCT GUIDE

BICYCLE ACCESSORIES
vg@v-grip.com.tw





We were established in 1976. We are not only professional in making the superior quality of the plastic accessories in bicycle and motorcycle field but also paying more attention in innovation & development.

There are many models that PAT. in many countries. In year 2000, Mr. Edward Huang created the range of unique design products line with the V-Grip brand. We have founded the market sales in OEM/ODM and OBM for all over the world.

Not just the ride for fun...
Not just the ride for comfortable...
Not just the ride for safe...

V-Grip is all of these. Having established the only concept on each innovative product with the best quality and unparalleled value. Product is not only the single function. More creative ideas than the expected on each project.

WATER BOTTLE & BOTTLE CAGE

- 02 HET™ Material Series
- 03 Insulated Bottle
- 04 Big Flow Cap Series
- 05 HI-VIS Reflective/L8 Big Flow Cap Series
- 06 Double Density /Season Bottle/Bottle Package
- 07 Standard Bottle Series
- 08-09 Bottle Cage

BIKE GRIP

- 10 Ergonomic Design/E-Bike Grip
- 11 Silicone Foam Series
- 12 Lock On Series / Foam Series
- 13 Leather Series
- 13-14 Barend Grip & Led Grip Series
- 15-16 BMX / Free Style
- 17 Colorful Grip Series
- 18-19 Handle Bar Tape & Plug End
- 20 Led Bar End & Unique Bar End
- 21 Bicycle Mirror Series

BIKE FENDER

- 22 Rattler Fender Series 24"-29"
- 23 Led Fender
- 24 Wing Design
- 25 Tablet Fender & Fat Bike
- 26 Children Bike 16"-20" Use
- 27-28 Other Fender
- 29 Chain Cover

BIKE ACCESSORIES

- 30 -31 Wheel Cover
- 32 Tool Zip Bag / Bottle Series
- 33 Macarons Led
- 34 Tool Bottle & Brush Set
- 35 Other LED Accessories
- 36 Helmet

MOTORCYCLE

- 36-37 Motorcycle Grip / Led End
- 38-41 Motorcycle Grip /Heated Grip

2019-2020 NEW PRODUCTS



V-611
MATERIAL: DURABLE COMPOSITE



V-441
Magnetic mounting adaptor facilitates rotation for easy bottle entry and removal. Dual sided operation (see photo)



V-184
L: 134 MM
ONE SIDE ALLOY RING
MATERIAL: PP/KRATON



V-194
L: 134 MM/90 MM AVAILABLE
ONE SIDE RING
MATERIAL: PP/KRATON

V-2729F
27.5"-29" USE

- Tool Free
- Interior headtube 19mm-35mm (2 adapters)
- Quick Release System Section: 80mm



V-2729R
27.5"-29" USE

- Tool Free
- Seat post: Φ 24-32mm
- Quick Release System Section: 80mm



V-669
Capacity: 800ml
Material: PP/HET
Cap Option: L8/L9



V-741
Capacity: 750ml
Material: LDPE/PP/HET
Cap Option: L2/L8/L9



V-9988-FV
Material: PP
Thickness: 1mm



Passed ISO 9001:2008
Quality Management Standard

HET™ Elastic Max

HET™-ELASTIC MAX

- High Elastic Technology material
- FDA/RoHS approved
- BPA free
- Proprietary HET material make the V-GRIP bottles Ultra flexiable-Easy squeeze-Delivery high water flow



NEW
V-669

Capacity: 800ml
Material: PP/HET
Cap Option: L8/L9



V-600C

Capacity: 750ml
Material: PP/HET
Cap Option: L2/L8/L9



V-409K

Capacity: 550ml
Material: PP/HET
Cap Option: L2/L8/L9



V-AK500

Capacity: 550ml
Material: PP/HET
Cap Option: L7J



V-AK750

Capacity: 750ml
Material: PP/HET
Cap Option: L7J

MATTE LOOKING SERIES



V-409K/M

Capacity: 550ml
Material: PP/HET
Cap Option: L2/L8/L9



V-AK500/M

Capacity: 550ml
Material: PP/HET
Cap Option: L7J



V-700G/M

Capacity: 750ml
Material: PP/HET
Cap Option: L2/L8/L9



V-AK750/M

Capacity: 750ml
Material: PP/HET
Cap Option: L7J



V-668

Capacity: 680ml
Material: PP/HET
Cap Option: L2/L6/L7J/L8/L9



NEW

V-669IB

Capacity: 750ml
Material: PP/HET
Cap Option: L7J/L8/L9



NEW

V-669

Capacity: 800ml
Material: PP/HET
Cap Option: L7J/L8/L9



NEW

V-741

Capacity: 750ml
Material: LDPE/PP/HET
Cap Option: L2/L8/L9



NEW

V-S550

Capacity: 550ml
Material: LDPE/PP/HET
Cap Option: L2/L8/L9



V-9000

Capacity: 750ml
Material: LDPE
Cap Option: L2/L8/L9



V-6000

Capacity: 550ml
Material: LDPE
Cap Option: L2/L8/L9

INSULATED BOTTLE

Keep water warm / Cool longer ; More Capacity



NEW

V-669IB

Capacity: 750ml
Material: PP/HET
Cap Option: L7J/L8/L9



V-668GB V-668PK

INSULATED BOTTLE
One-handed push button operation
Capacity: 680 ml
Patent Pending
Material: PP/HET

V-668RB V-668PK V-668GB

Capacity: 680ml
Material: PP/HET
Cap Option: L2/L6/L7J/L8/L9



V-650AAR

Capacity: 550ml
Material: PP/HET
Cap Option: L7J/L5J
PAT.



V-650AAS

Capacity: 550ml
Material: PP/HET
Cap Option: L5J/L7J
PAT.



V-650AA

Capacity: 550ml
Material: PP/HET
Cap Option: L7J/L5J
PAT.



V-650AAS

Capacity: 550ml
Material: PP/HET
Cap Option: L5J/L7J
Unique spout valve-push to open, release to close.



V-700AA

Screw cap
Capacity: 500ml
Material: PP
Cap Option: L2/L8/L9



V-600AAH V-600AAC V-600AAU V-600AAI

Screw cap
Capacity: 400ml
Material: PP
Cap Option: L2/L8/L9

BIG FLOW CAP SERIES



NEW
V-741
 Capacity: 750ml
 Material: LDPE/PP/HET
 Cap Option: L2/L8/L9



NEW
V-S550
 Capacity: 550ml
 Material: LDPE/PP/HET
 Cap Option: L2/L8/L9

Fill line Series



V-AK500W

Capacity: 500ml
 Material: LDPE
 Cap Option: L7J
 PAT.

V-AK750W

Capacity: 750ml
 Material: LDPE
 Cap Option: L7J
 PAT.

V-AK1000W

Capacity: 1000ml
 Material: LDPE
 Cap Option: L7J
 PAT.

V-AK500

Capacity: 500 ml
 Material: LDPE
 Cap Option: L7J
 PAT.

V-AK1000

Capacity: 1000 ml
 Material: LDPE
 Cap Option: L7J
 PAT.

V-AK750

Capacity: 750 ml
 Material: LDPE
 Cap Option: L7J
 PAT.



V-AK500

Capacity: 500 ml
 Material: LDPE
 Cap Option: L5J

V-AK1000

Capacity: 1000 ml
 Material: LDPE
 Cap Option: L5J

V-AK750

Capacity: 750 ml
 Material: LDPE
 Cap Option: L5J

T-TURBO

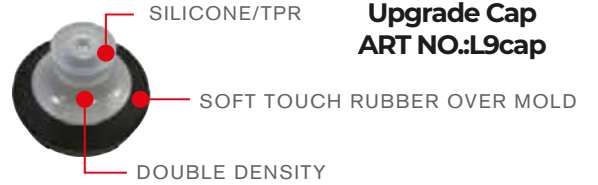

Upgrade Cap
ART NO.:L9cap



ART NO: L2 cap

Basic Standard Cap
 With Small Valve



ART NO.: L5J cap
 Spill-proof valve.
 Push to open; release to close
JET MOUTH



ART NO.: L7J cap
 High water flow & spill proof
 silicone valve
JET MOUTH



ART NO.: L8 cap
 Big flow cap
 Valve Option: TPR/Silicone

L8 BIG FLOW SERIES



NEW
V-S550
Capacity: 550ml
Material: LDPE/PP/HET
Cap Option: L2/L8/L9



NEW
V-741
Capacity: 750ml
Material: LDPE/PP/HET
Cap Option: L2/L8/L9



V-700A
Capacity: 800ml
Material: LDPE/PP/HET
Cap Option: L2/L8/L9

CWB600C
Capacity: 750ml
Material: LDPE/PP/HET
Cap Option: L2/L8/L9



CWB600CT
Capacity: 750ml
Material: K-RESIN
Cap Option: L2/L8/L9



CWB700GTS
Capacity: 750ml
Material: K-RESIN
Cap Option: L2/L8/L9



CWB700C
Capacity: 750ml
Material: LDPE
Cap Option: L2/L8/L9

Hi-Vis REFLECTIVE SERIES



V-668RE
Capacity: 680ml
Material: PP/HET
Cap Option: L2/L6/L7J/L8/L9

Chocolate Vanilla Grapes Orange



V-9000S
Screw cap
Capacity: 750 ml
Material: LDPE
Scented
Anti-Slip
Cap Option: L2/L8



CWB600C/C1
Capacity: 750ml
Material: LDPE/PP/HET
Cap Option: L2/L8/L9

V-9000
Capacity: 750ml
Material: LDPE
Cap Option: L2/L8/L9

V-6000
Capacity: 550ml
Material: LDPE
Cap Option: L2/L8/L9



V-409K
Capacity: 550ml
Material: LDPE/PP/HET
Cap Option: L2/L8/L9



V-409KA1
Capacity: 550ml
Material: LDPE
Cap Option: L2/L8/L9



CWB409KT
Capacity: 550ml
Material: K-RESIN
Cap Option: L2/L8/L9

WATER BOTTLE SERIES

The series of V-GRIP bottles are made from BPA free / FDA and RoHS approved material.



V-409KS

Capacity: 550 ml
Material: LDPE
Cap Option: L2/L8/L9

V-600CS

Capacity: 750 ml
Material: LDPE
Cap Option: L2/L8/L9



12pcs / Each box



52pcs / Each box

DOUBLE DENSITY BOTTLE



V-9000

Capacity: 750ml
Material: LDPE
Cap Option: L2/L8/L9

V-6000

Capacity: 550ml
Material: LDPE
Cap Option: L2/L8/L9

STANDARD BOTTLE SERIES

750ml Series



V-700A

Capacity: 800ml
Material: LDPE/PP/HET
Cap Option: L2/L8/L9



CWB600C

Capacity: 750ml
Material: LDPE/PP/HET
Cap Option: L2/L8/L9



CWB600C/L3

Capacity: 750ml
Material: LDPE
Cap Option: L3



CWB600CT/C1

Capacity: 750ml
Material: K-Resin
Cap Option: L2/L8/L9



CWB600C/C1

Capacity: 750ml
Material: LDPE/PP/HET
Cap Option: L2/L8/L9



V-600C/V

Capacity: 750ml
Material: LDPE
Cap Option: L2/L8/L9



CWB600CT

Capacity: 750ml
Material: K-RESIN
Cap Option: L2/L8/L9



CWB700GTS

Capacity: 750ml
Material: K-RESIN
Cap Option: L2/L8/L9



CWB700GTS

Capacity: 750ml
Material: K-RESIN
Cap Option: L2/L8/L9



***NEW* V-741**

Capacity: 750ml
Material: LDPE/PP/HET
Cap Option: L2/L8/L9



CWB700G

Capacity: 750ml
Material: LDPE/PP/HET
Cap Option: L2/L8/L9



CWB700ET

Capacity: 750ml
Material: K-Resin
Cap Option: L2/L8/L9



CWB700C

Capacity: 750ml
Material: LDPE
Cap Option: L2/L8/L9



CWB500C

Capacity: 750ml
Material: LDPE
Cap Option: S1



CWB500DT

Capacity: 750ml
Material: K-Resin
Cap Option: S1



CWB500A-1

Capacity: 750ml
Material: LDPE
Cap Option: L1

550ml Series



***NEW* V-S550**

Capacity: 550ml
Material: LDPE/PP/HET
Cap Option: L2/L8/L9



V-409K

Capacity: 550ml
Material: LDPE/PP/HET
Cap Option: L2/L8/L9



CWB409KT

Capacity: 550ml
Material: K-RESIN
Cap Option: L2/L8/L9



CWB409KT/C1

Capacity: 550ml
Material: K-Resin
Cap Option: L2/L8/L9



V-409KA2

Capacity: 550ml
Material: LDPE
Cap Option: L2/L8/L9

350ml Series



CWB409M

Capacity: 350 ml
Material: LDPE



CWB409W2

Capacity: 350 ml
Material: LDPE



CWB409W4

Capacity: 350 ml
Material: LDPE



CWB409W5

Capacity: 350 ml
Material: LDPE



CWB409W6

Capacity: 350 ml
Material: LDPE



CWB409W7

Capacity: 350 ml
Material: LDPE

BOTTLE CAGE



NEW
V-611
MATERIAL: DURABLE
COMPOSITE



NEW
V-441
Magnetic mounting adaptor
facilitates rotation for easy
bottle entry and removal. Dual
sided operation (see photo)



PAT.

V-637
PAT.
Adjustable Cage
Available 350ml ~ 1000ml
All bottle size are available



V-636
Material: Alloy
Available: Color Option
weight: 38 g

- Durable Material / Super-Weighted / Nice Fit
- Easy in/out
- Available: color options
- Logo laser inscribe

Side Access



L

R

Z-Cage

V-635
Material: Nylon+Fiber
Available: Color Option
Easy in / out accessibility
Side Access
PAT.

GOODY

CARBON LOOKING



V-634
Material PC



CWB9966
Assemble in Handle Bar
Available in 22.2~31.8 Handle Bar

CARBON FIBER



V643
Weight:27g



V647
Weight:30g



V649
Weight:36g



V653
Weight:11g



V655
Weight:24g



CWB9121
Material Nylon



CWB6
Material:Alloy



CWB5
Material:Alloy



CWB033
Material:Alloy



CWB034
Material:Alloy

CARBON FIBER

FOR 350CC



V-638
Weight:24g



V-639
Weight:24g



V-640
Weight:24g



CWB9288
Material : PP



CWB9289
Material : PP



CWB9290
Material : PP
Easy in / out

E-BIKE GRIP



NEW
V-184
L: 134 MM
ONE SIDE ALLOY RING
MATERIAL: PP/KRATON



NEW
V-194
L: 134 MM/90 MM AVAILABLE
ONE SIDE RING
MATERIAL: PP/KRATON

ERGONOMIC DESIGN

REVOLUTIONARY LED AND GRIP COMBINATION

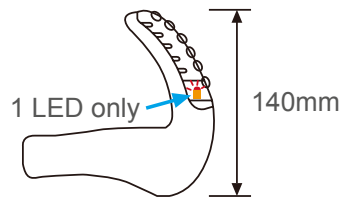

ER-188LED
L: 148mm/ 95mm
Triple density material Kraton / Nylon + Fiber
PAT.

PAT.

- The series of LED by V-Grip use 1 single LED with the “obverse beam by light-guide panel technology”.
- With this technology, it could make the most efficiency to get powerful light.
- Result is the powerful light & less power consumption.



Touch here on off

PRODUCT FEATURES

- 1 LED only. Reduce more energy consumption.
- 3 LED functions-Steady/ Flash/ Speedy Flash.
- Ergonomic design.
- Power source-2 x CR2032

LOCK ON SERIES

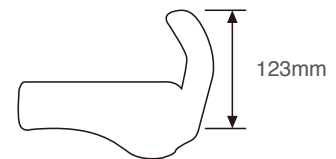

ERI-AC
L: 134mm
Triple Materials Kraton/ Gel
W/ Alloy Ring



ERIA2
L: 137mm
Triple Density Material
Alloy Clamp
Class: High Quality
Bar End Material: Nylon + Fiber

- PAT**
- 6 product features
- Ergonomic design
 - Materials are made of kraton/gel by USA shell brand.
 - Super light alloy bar-end grip. The weight 122g/1pc only.
 - PAT. for angle index adjustment.
 - Triple materials on all palm area design. Be comfortable & shock-absorbing for the long riding.
 - Lock with screw fixation design.

SILICONE FOAM SERIES

ULTRA-LIGHT WEIGHT

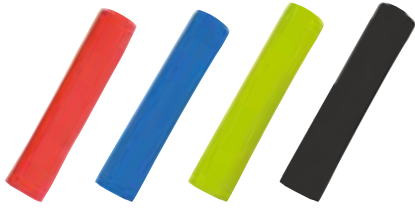

CWG-018SL

L: 130mm
WEIGHT: 29g/PC



NEW
CWG-019SL

L:133mm
WEIGHT: 43.5g/PC



CWG-018AC1

L:130mm

SILICONE FOAM ULTRA-LIGHT WEIGHT



CWT926SL

L:185 cm



CWT926SL/C

L:185 cm

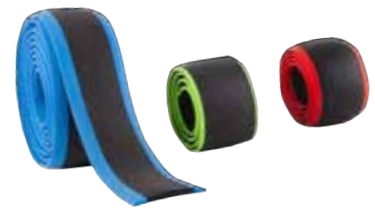

CWT927SL

L:185 cm



One ring

Silicone Foam Grip

CWG016AC-1R

Material : Silicone
One ring : L:130 mm



Two ring

Silicone Foam Grip

CWG016AC-2R

Material : Silicone
Two ring : L:133 / 140mm



Silicone Foam Grip

CWG016SL-2T

L:130mm
Material Silicone



Silicone Foam Grip

CWG016SL

L:130mm
Material: Silicone

LOCK ON SERIES

Standard



V-20688

L: 130mm
Double density Materials Kraton/ Gel



V-9140

L: 140mm / 125mm / 112mm
Material: Kraton



V-818ACS

L:130mm
W/ Alloy Ring
Transparent Colorful Grip



V-588AC

L:130mm
Triple Density Material Gel/ Kraton
W/ Alloy Ring
PAT.



V-588ACD

L:130mm
Triple Density
Material Gel/ Kraton
W/ Alloy Ring Swarovski Crystal
PAT.



V-818AC

L:130mm / 95mm
Double Density
Material Kraton
W/ Alloy Ring



Close End

V-588FCE

L:134mm
Triple Density Material Gel/ Kraton
W/ Alloy Ring
PAT.



Close End

V-588CE

L:132mm
Triple Density Material Gel/ Kraton
W/ Alloy Ring
PAT.



Carbon
Locking

V-818ACC

L:130mm/ 95mm
Double Density Material Kraton
W/ Alloy Ring

FOAM SERIES



V-818ACH-01

Lock Foam Grip L: 130mm
Double Density Material Foam W/ Alloy
Ring
2 Side lock



V-818ACH-02

Lock Foam Grip L: 130mm
Double Density Material Foam W/ Alloy Ring
1 Side lock



V-818ACH-03

Lock Foam Grip L: 130mm
Double Density Material Foam W/
Alloy Ring
1 Side lock



V-818ACH-04

Lock Foam Grip L: 130mm
Double Density Material Foam W/ Alloy
Ring
1 Side lock



V-818H-05

L: 127mm
High Density Foam Grip



V-20688L

L: 130mm
 Made from Gel Covered Leather
 Hand-Stitched
 Color: Brown



V-20688L

L: 130mm
 Made from Gel Covered Leather
 Hand-Stitched
 Color: Black



V-818ACL

L: 130mm
 Made from Gel Covered Leather
 Hand-Stitched
 Color: White



V-818ACL

L: 130mm
 Made from Gel Covered Leather
 Hand-Stitched
 Color: Brown



V-818H6L

L: 127mm
 Made from Foam Covered Leather
 Hand-Stitched



V-818H6L-01

L: 90mm/ 102mm/ 110mm
 Made from Foam Covered Leather
 Hand-Stitched

BAREND GRIP



Ergonomic Design



V-ER188

L: 148mm/ 95mm
 Triple Density Material Gel / Nylon + Fiber



V-1071F

Material Alloy
 logo laser inscribe



V-818ACD

L: 130mm
 Triple Density Material Gel/ Kraton
 W/ Alloy Ring Swarovski Crystal

BAREND GRIP



V-689BEN Nylon+Fiber Barend

L:137mm
Triple Density Material Gel /
Kraton W/ Nylon +
Fiber Barend



V-588BE

L:137mm
Triple Density Material Gel /
Kraton W/ alloy barend



V-818BEC Alloy Barend

L:137mm
Triple Density Material Gel /
Kraton W/ alloy barend

Carbon
Locking



V-818BEN

L:137mm
Triple Density Material Gel /
Kraton W/ Nylon+Fiber barend



L:133mm

V-689

L:133mm / 92mm
Double Density Material Gel /
Kraton



L:92mm



V-103

L: 120mm
Material: Alloy / Kraton



V-104

L: 120mm
Material: Alloy / Kraton

LED GRIP SERIES



V-103BLED

L: 145mm
Material: Kraton / Alloy



V-104BLED

L: 145mm
Material: Kraton / Alloy

Touch here



BMX / FREE STYLE

WATER BOTTLE &
BOTTLE CAGE

BIKE GRIP

BIKE FENDER

BIKE ACCESSORIES

MOTORCYCLE



V-9140OB

L:140mm
Material:Kraton



V-9140

L:140mm/ 125mm / 112mm
Material:Kraton



CWG-20588B

L: 128mm
Double Density Material / Kraton
PAT.



CWG20289

L:125mm
Double Density Material
Gel/ kraton



CWG-20668

L:132mm
Double Density Material
Gel/ kraton



V-9999B

L:140mm
Double Density Material
Gel/ kraton



CWG-30386B

L:130mm
Double Density Material
Gel/ kraton



CWG-20589B

L:128mm
Double Density Material
Gel/ kraton



CWG-810

L:120mm
Double Density Material
2 Color PVC



CWG-800

L:120mm
Double Density Material
2 Color PVC



V-9140OB

L:140mm
Material:Kraton



V-9140AC Lock On

L:148mm
Triple Density Material Gel/
kraton W/ alloy
clamp



CWG-908

L:124mm
Matreial Kraton/ PVC



CWG-9728

L:130mm
Matreial Kraton/ PVC



V-9140

L:140mm/ 125mm/ 112mm
Material:Kraton



CWG-30388BM

L:128mm
Double Density Material
Gel/ kraton



V9999

L:130mm
Double Density Material
Gel/ kraton



CWG-9308

L:125mm
Material kraton/ PVC



CWG-9813

L:115mm
Material kraton/ PVC



**CWG-9333
CWG-9333A**

Endless

L: 85mm
Material kraton/ PVC



**CWG-S120
CWG-S120A**

Endless

L: 120mm
Material kraton/ PVC



**CWG-S102
CWG-S102A**

Endless

L: 102mm
Material kraton/ PVC



**CWG-339
CWG-339A**

Endless

L: 92mm
Material kraton/ PVC



**CWG-340
CWG-340A**

Endless

L: 75mm
Material kraton/ PVC



**CWG-9923L
CWG-9923**

L:120mm
L:85mm

Double Density Material
Gel/ kraton



CWG9246



CWG509

Size:4-1/2"(L)x20mm(D)



CWG605

Size:4-1/4"(L)x20mm(D)



CWG750

Size:3-3/4"(L)x20mm(D)



CWG9128

Size:130mm(L)x20mm(D)



CWG605A

Size:4-1/8"(L)x20mm(D)

COLORFUL GRIP SERIES



V-CC01 Chain Protector

L225mm
Material: Rubber
Back Side With 3M Sticker



Display Box



CWG-20588BM

L: 128mm
Double Density Material Gel/ Kraton
PAT.



CWG015

L160mm
Material Kraton



V-180

L180mm
Material kraton/ PVC



CWGB001

L120mm
Double Density Material
Gel/ kraton



CWG9755

L120mm
Material kraton

EVA



CWT917-W



CWT917-BL



CWT917-BK



CWT917-R



CWT917CL



CWT917CR



CWT917CW



CWT917CA

CWT917CB



CWT919-B/W



CWT919-B/R



CWT919-B/BL



CWT919-B/Y

PU HEXAGON LOOKING



CWT917H-B



CWT917H-W



CWT917H-R



CWT917H-BL

PU



CWT919S-R



CWT919S-BL

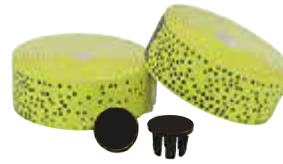

CWT919S-Y



CWT919S-G



CWT919H-W



CWT919H-B



CWT919H-R



CWT919H-BL

PU



CWT919E-B



CWT919E-R



CWT919E-R/B



CWT919E-BL/B

EVA+CORK



CWT919X



CWT918-W



CWT918-Y

PU CARBON LOOKING



CWT919CBL



CWT919CR



CWT919CBK

SILICONE FOAM

Ultra-Light Weight

NEW



CWT926SL

CWT926SL/C



CWT927SL

PLUG END



V-1071F

Material Alloy
logo laser inscribe



CWP-1071A



CWP-1071B



CWP-1071C



CWP-1071D



CWP-1071E

BAR END LED

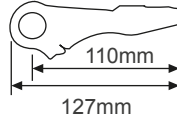

1 LED only
Save more energy
consumption

V-BE2NLED

Material: Nylon + Fiber
Weight: 55g/ each
Sustainable light 130hrs



CWP-1071B



UNIQUE BAR END LIGHT-WEIGHTED DESIGN



PAT.

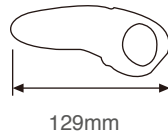

V-BE3N

L:129mm
Material: Nylon + Fiber
Angle index adjustment
PAT.

Ultra-light weight



V-BE1

L: 95mm
Material: Alloy
Weight: 60g/ each
PAT.

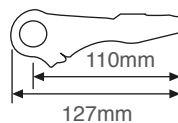

V-BE2NBK

Material: Nylon + Fiber
Weight: 52g/ each

Ultra-light weight

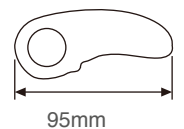

V-BE1-N

L:95mm
Material: Nylon + Fiber
Weight: 50g/ each

BICYCLE MIRROR SERIES

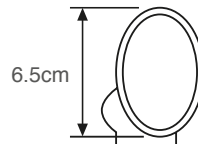

NO:V-4064

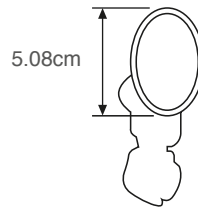

NO:V-4066

Mini Mirror

NEW

V-4064/V-4066

Material PP

Mini Shape

Available any type handlebar and fork

Tool free easy assembled

Adjustability 360° rotation

PAT.

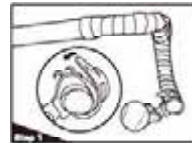

Tighten Belt

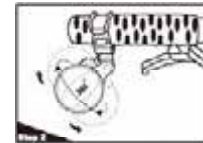

Adjustability, 360° Rotation
Without Tool Tighten on Grip Top

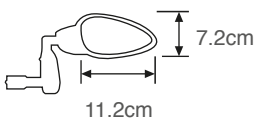

V-4063

Material PP

Available in left /right

ø11.2cm x 7.2cm



V-4063BL

Material PP

Anti-dazzle

Available in left /right

ø11.2cm x 7.2cm

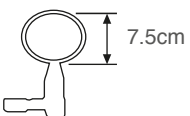

V-4065

Material PP

Available in left /right



V-4065BL

Material PP

Anti-dazzle





Available in left /right

RATTLER FENDER SERIES

ULTRA-LIGHT WEIGHT





Available most of any suspension fork

V-2426F

-  Wheel size:24"-26"
-  Tool Free
-  Interior headtube
19mm-35mm (2 adapters)
-  Quick Release System
-  L:570 mm Section:80mm







V-2426R

-  Tool Free
-  Seat post:Φ24-32mm
-  Wheel size:24"-26"
-  Quick Release System
-  L:530 mm Section:80mm







V-2627F





-  Wheel size:26"-27.5"
-  Tool Free
-  Interior headtube
19mm-35mm (2 adapters)
-  Quick Release System
-  L:590 mm Section:80mm



V-2627R





-  Tool Free
-  Seat post:Φ24-32mm
-  Wheel size:26"-27.5"
-  Quick Release System
-  L:550 mm Section:80mm

V-2729F

-  Wheel size:27.5"-29"
-  Tool Free
-  Interior headtube
19mm-35mm (2 adapters)
-  Quick Release System
-  L:655 mm Section:80mm



V-2729R

-  Tool Free
-  Seat post:Φ24-32mm
-  Wheel size:27.5"-29"
-  Quick Release System
-  L:615 mm Section:80mm



V-1F
26" Front Fender



Standard Clamp

V-2R-OT
V-2R- PL

26" Rear Fender

- Tool free
- Tire w<2.35"
- 26" MTB
- Quick Release

LED FENDER



PAT. TECHNOLOGY

- The series of led by V-Grip use 1 single led with the "obverse beam by light-guide panel technology"
- With this technology, it could make the most efficiency to get powerful-light.
- Result is the powerful light & less power consumption.

V-LED1F

26" Front Fender

Product feature

- Led Fender is a global pioneer design for fender and Led light combination. It makes the fender not only single fender but also multi-functions. Pat. In many countries.
- Only 1 PC of small Led light input and get the Max. light power through the light guard.
Be easy to get warning function.
- 160 hrs of continuous usage / 1 PC battery
- Adjust the best angle w/o any tool easily for quick-released clamp on seat post.

Two Options



OT
Tool Free
Quick Releas



PL
Standard

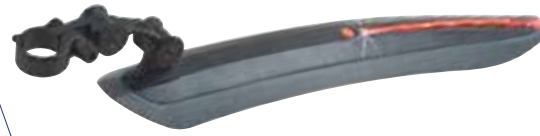

V-LED1R/OT

26" Rear Fender



V-LED2R/OT

26" Rear Fender
Single Color



V-LED2RT/OT

- 26" Rear Fender
- Tool free
- Tire w<2.35"
- LED Light
- 26" MTB
- Quick Release

Two Options OT or PL



OT

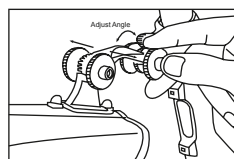

- TOOL FREE
- QUICK RELEASE
- ANGLE ADJSUTMENT



PL

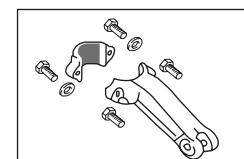

- STANDARD ASSEMBLED ON SEAT POST

WING DESIGN

Light as the wing

PAT. TECHNOLOGY



V-SSILEDR

Rear

- Assemble on bridge
- Light Weighted
- Tire w=1.25" ~ 1.75"
- LED Light
- 20"~700C
- Quick Release
- 130 hours
- PAT.**



V-SSILEDTR/OT

Rear

- Assemble on seat post
- Light Weighted
- Tire w=1.25" ~ 1.75"
- LED Light
- 20"~700C
- Quick Release
- 130 hours
- PAT.**



V-SSILEDIR/OT

Rear

- Assemble on seat post
- LED Light
- 130 hours
- PAT.**



V-SSIF

Front

- Front Fender
- Assemble on bridge
- 3M Reflector Sticker



V-SSIR/OT

Rear

- Assemble on seat post
- Tool free
- 20"
- Quick Release
- 3M Reflector Sticker



V-SSIR

Rear

- Assemble on bridge
- Tool free
- Light Weighted
- 20"~700C
- Tire w=1.25" ~ 1.75"
- 3M Reflector Sticker



Standard clamp

V-SSILEDIR/PL

Rear

- Assemble on seat post
- LED Light
- General grade
- 130 hours
- PAT.**



Standard clamp

V-SSIR/PL

Rear

- Assemble on seat post
- 20"
- Quick Release
- 3M Reflector Sticker
- General grade

⓪ Touch here



Button For Slipping Off



Button For Angle Adjustment

Touch here ⓪

TABLET FENDER

Front



NEW
V-9988FV
Front Tablet Fender
Material:PP
Thickness:1mm

Rear



NEW
V-9988RV
Rear Tablet Fender
Material:PP
Thickness:1mm

Front

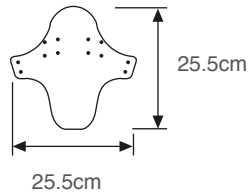

V-9988-F
Front Tablet Fender
Material PP
Thickness : 0.6mm

Rear

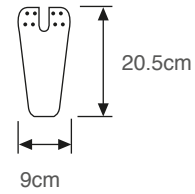

V-9988-R
Rear Tablet Fender
Material PP
Thickness : 0.6mm

Front

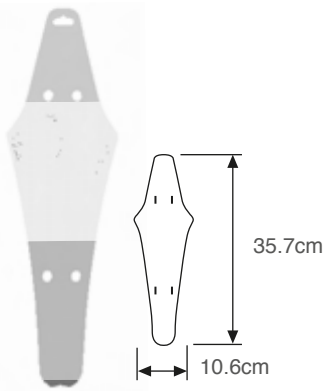

V-9988-DF
Tablet Fender, Material PP
Assemble in downtube
Thickness : 1.0mm
PAT.



Rear



V-9988-RL
Tablet Fender
Material PP
Thickness : 1.0mm
PAT.



FAT BIKE

Front



V-9988-XDF
Tablet Fender
Material PP
Assemble in downtube
Thickness : 1.0mm



Front

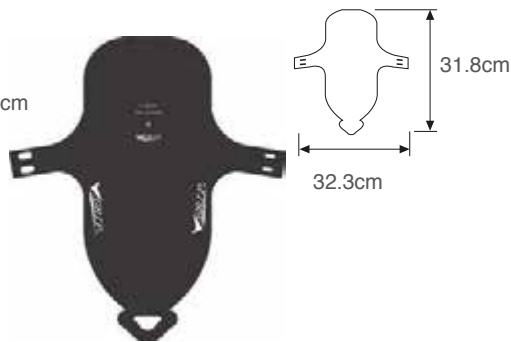

V-9988-XF
Tablet Fender
Material PP
Thickness : 1.0mm

Rear



V-9988-XR
Tablet Fender
Material PP
Thickness : 1.0mm
PAT.

CHILDREN BIKE 16"-20" USE

V-1FS

20" Front Fender



V-1FR

16"/20"
Rear Fender



V-1FF

16" Front or Rear Fender

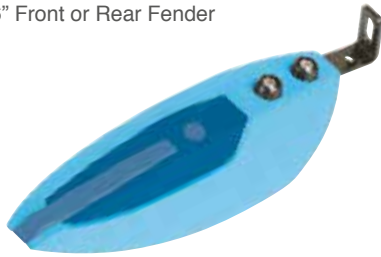

V-LED1FST

20" Front Fender



V-LED1FS

20" Front Fender

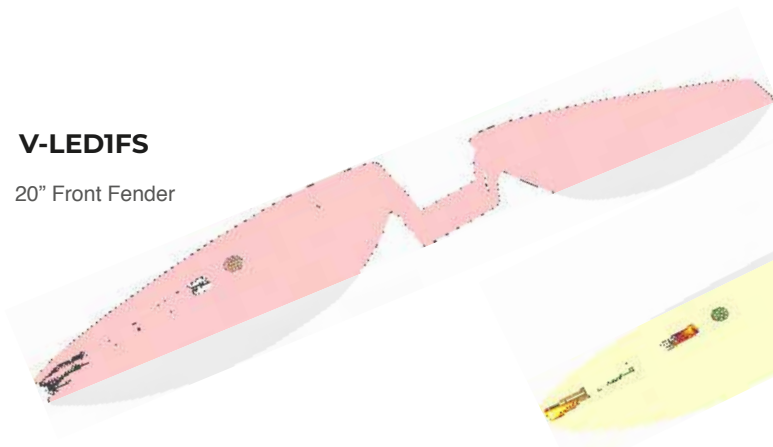

V-LED1RF

16"/20"
Rear Fender

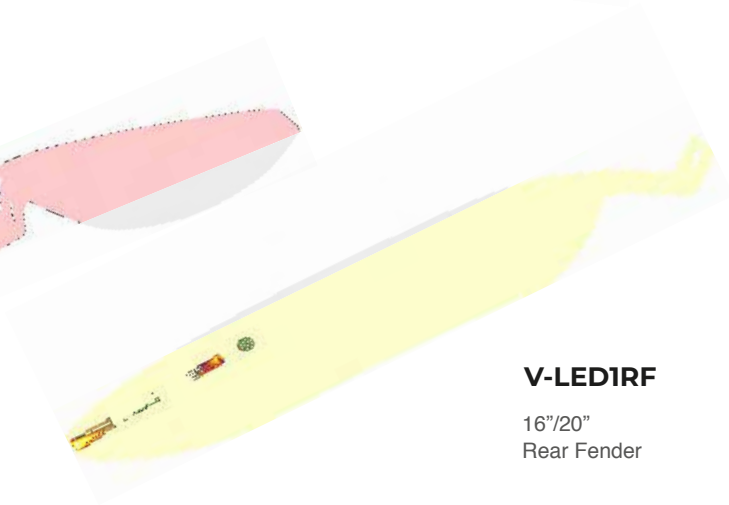

V-LED1FF

16" Front or Rear Fender



OT

OTHER FENDER

9977 Series



MTB Down tube Fender



V-9977-S1

Paint
Material PP

V-9977-C2

Carbon Fiber looking
Material PP

26" Series



CWF20386-F CWF20386-R

26" BIKE
Material PP



CWF20386-FRFS CWF20386-RRFS

26" BIKE
Material PP



CWF20386-FWF CWF20386-RWF

26" BIKE
Material PP



CWF20386-FMR CWF20386-RMR

26" BIKE
Material PP

20066 Series



CWF20066-FGF CWF20066-RGF

26" BIKE
Material PP



CWF20066-F CWF20066-R

26" BIKE
Material PP



CWF20066-FK CWF20066-RK

26" BIKE
Material ABS/PP

26" Series



CWF20026-FBFS CWF20026RBFS

26" BIKE
Material PP

OTHER FENDER

26" Series



CWF20026-FGF
CWF20026-RGF

26" MTB
Material PP



Light Weighted

CWF20026-FJK
CWF20026-RJK

26" MTB
Material PP/Carbon Looking



CWF20026-F
CWF20026-R

26" MTB
Material PP



CWF20026-FMB
CWF20026-RMB

26" MTB
Material PP



CWF20026-FRA
CWF20026-RRR

26" MTB
Material PP



CWF20026-FWA
CWF20026-RWA

26" MTB
Material PP

FOR CHILDREN'S BIKE USED 16"-20" Series



CWF20386S

26" MTB
Material PP



CWF2020-FMR
CWF2020-RMR

16"~20" BIKE
Material PP



CWF2020-FMS
CWF2020-RMS

16"~20" BIKE
Material PP



CWF2020-FRF
CWF2020-RRF

16"~20" BIKE
Material PP

CHAIN COVER

WATER BOTTLE & BOTTLE CAGE

BIKE GRIP

BIKE FENDER

BIKE ACCESSORIES

MOTORCYCLE



CWC20027C1

36T/38T
24", 26". 700C, 28"
Size: a515. b425. c118
Material PC/ABS



CWC20028

42T-44T
Size : a520 . b420 . c165



CWC20033W1

30T/34T
Size: a502. b418. c102
Material PC/ABS

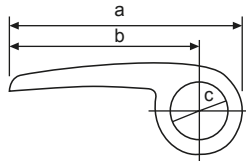

CWC20033

30T/34T
Size: a502. b418. c102



CWC20027

36T/38T
24", 26". 700c. 28"
Size: a515. b425. c118



CWC20029

46T-48T
Size : a545 . b430 . c173



CWC421A

20"
Size : a420 . b317



CWC422A

16"
Size : a335 . b245



CWC427A

20"
Size : a440
F \varnothing 25.4~ \varnothing 50
R \varnothing 16~ \varnothing 26

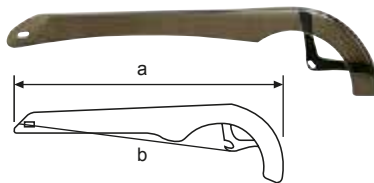

CWC424

24~26"
Size : a540 . b415



Dressing-Guard Series

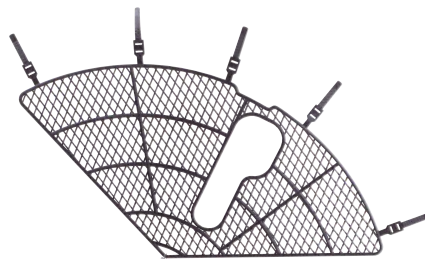

CWD20698

700C

Chain Protector

V-CC01

L225mm
Material: Rubber



CWC430A



CWC430B



CWC430C



CWC430D

WHEEL COVER

12"~700c"



CWW433
12"

16"-20"



CWW9516
16"



CWW428A
16"/20"/26" MTB/BMX



CWW423
20" BMX



CWW428E
16"/20"



CWW428N
16"/20"



CWW428P
16"/20"



CWW9970
16"/20"



CWW9469
16"/20" MTB/BMX

20"-26"



CWW428G
20" MTB/BMX



CWW428M
20" MTB/BMX



CWW9669
20"~26" MTB



CWW9957
26" MTB



972C
L:110mm



972E
L:60xΦ23mm



972I
L:140xΦ23mm
L:180xΦ23mm



972J
L:140xΦ26mm



972L
L:100xΦ26mm



972A
L:140xΦ26mm



972B
L:140xΦ23mm



972M
L:240mm

WHEEL COVER

WATER BOTTLE
BOTTLE CAGE

BIKE GRIP

BIKE FENDER

BIKE ACCESSORIES

MOTORCYCLE



CWG-9813

L:115mm
Material kraton/ PVC



Wheel Chair



FIXED BIKE

Transparent Series
Material PVC
20"/24"/26"/700C

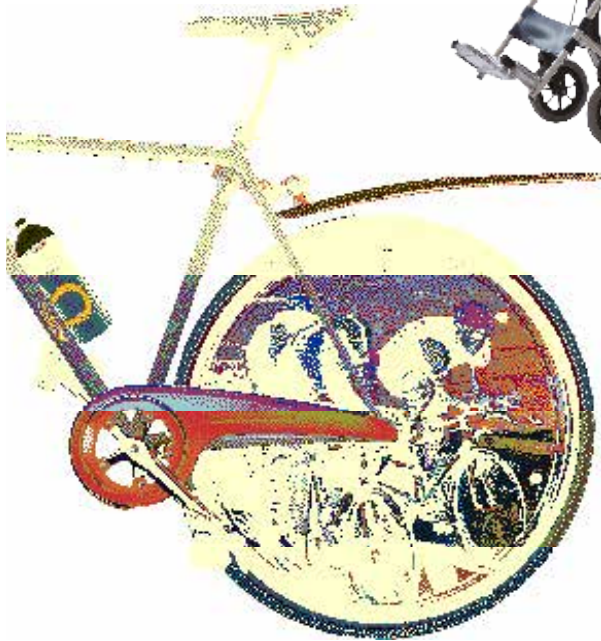

26"

Fixed Bike



CWW9958

26" MTB



CWW9959

26"



CWW9789

26" MTB



26"~700C

Number Plate



CWN20017



CWN20025



CWN3016

12"~20"



CWN20015A



CWN20033

TOOL ZIP BAG / TOOL BOTTLE SERIES



V- TP760MU
Material: Mutispandex

- Fits most standard bottle cages or a jersey pocket.
- Internal mesh pockets for inner tubes, Tire levers, Multi-tools, etc.



V- TP760PU
Material: PU

V- TP760NY
Material: Nylon

Flexible Length



V-TP750
MATERIAL: PP



R/W



BL/W



W/BK



BK/G



T/S

MACARONS

Pretty and strong



V-MK001

Material: **Silicon + PC**

- PATENTED 360 Led lens
 - Covered by silicone rubber for 360 protection and visibility
 - Long run time with 1 led design
 - Use: simply fit anywhere you like
- PAT.**

Silicone Rubber

Simply fit
anywhere you like

Patented 360 led lens
long run time with 1 led



TOOL BOTTLE & BRUSH SET

Flexible Length



V-TP750
Material:PP



R/W

BL/W

W/BK

BK/G

T/S

BRUSH SERIES



V-10066



V-666

V-760



V-760-03



V-760-02

V-760-01

MOTORCYCLE USE



V-3570



CWP4366-3C
L:330/550MM

MOTORCYCLE ALARM



CWRS300

OTHER LED ACCESSORIES



V-011

LED Air Valve

- VG patented 1LED technology for long lasting battery life
- Motion(Vibration) & light sensor for convenience



V-LED2PH

LED Shoes Clip

- 2 Mode: steady and flashing
- Power source: USB re-chargeable
- Available in shoes or arm
- 2 LED only

PAT.



V-LEDB2
1 LED only



V-LEDB1
1 LED only

Luma Pedal by vibration



LED-P1-SS

HELMET



CWH-106K

- 18 Vent With Twin Shell Design
- 2 Colors PC Shell
- Size: 56~59 cm
- Black Foam Padding



MOTORCYCLE GRIP LUMA GRIP LED SERIES

Product feature

- Illuminated Grip Handle & Barend
- With 6 Leds' On Grip Really Grab Your Attention
- Can Be Wire To Run Signals. Making Your Tour Even More Visible And Safe.

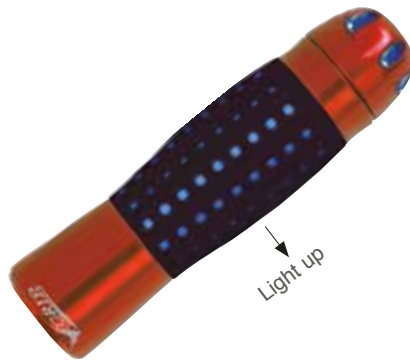

V-103LED

L145mm
Triple Density Material PP/Kraton/Alloy



V-104LED

L150mm
Triple Density Material PP/Kraton/Alloy



V-101LED

L150mm
Triple Density Material Gel/Kraton/Alloy



V-102EDA

L150mm
Triple Density Material Gel/Kraton/Alloy





V-103

L120mm
Double Density Material
Alloy/Kraton



V-104

L120mm
Double Density Material
Alloy/Kraton

CW-02LED1

Material Alloy
6 LEDs



Product Features

- AVAILABLE IN ANY GRIPS
- WITH 6 LEDs
- CAN BE WIRED TO HEAD LIGHT/BRAKE LIGHT/SIGNALS.



CW-01LED1

Material Alloy
6 LEDs



CWR009



CWP01



CWP02



CWP03



CWP04



CWM20807

MOTORCYCLE GRIP

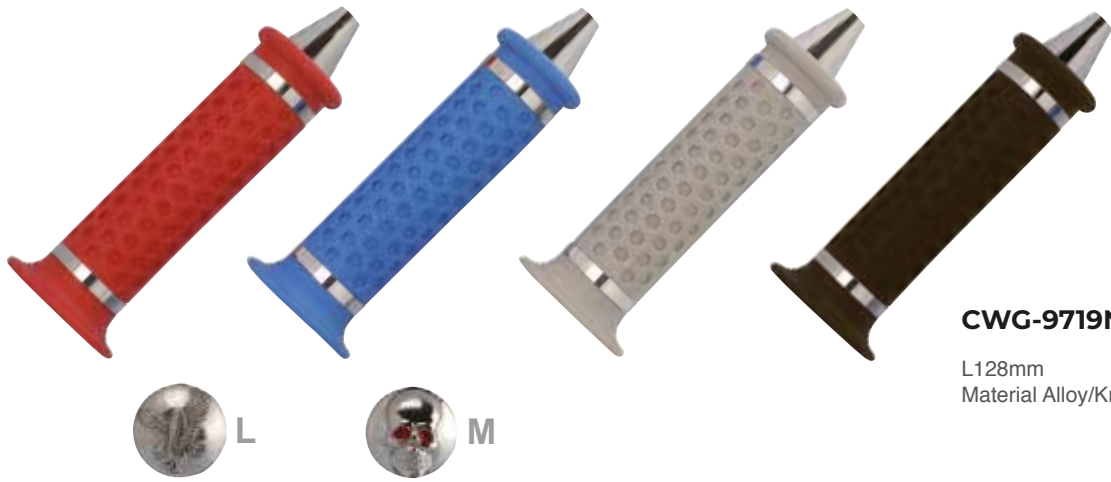

CWG-9719N

L128mm
Material Alloy/Kraton



CWG-20668

L128mm
Double Density Material
Gel/kraton



CWG-30386

L130mm
Double Density Material
Gel/kraton



CWG-20589

L128mm
Double Density Material
Gel/kraton

Packages



PK04



PK03



PK05

MOTORCYCLE GRIP



CWG-20387G

L135mm
Material Alloy



CWG-20387R

L135mm
Material Alloy



CWG-20387BL

L135mm
Material Alloy



CWG-20387B

L135mm
Material Alloy



E



CWG-20387CP

L135mm
Material Alloy



E



CWG-20387BR

L135mm
Material Alloy



E



V-9720-1

L132mm
Material Alloy/Leather



V-9720-6

L132mm
Material Alloy/Leather



CWG-9508LS

L135mm
Material Leather
Hand-Stitched
Available in 1" & 7/8" Handlebar

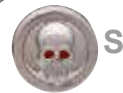

S



CWG-9565



**CWG-20589E
CWG-9508LE**

L135mm
Material Leather
Hand-Stitched
Available in 1" & 7/8" Handlebar



E



**CWG-30382
CWG-20389S**

L135mm
Double Density Material
Gel/kraton

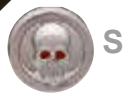

S

Universal



CWG-9519

L135mm
Material kraton
Available in 1" & 7/8" Handlebar



CWG-9507

MOTORCYCLE GRIP



CWGM004 Lock-on Grip

1. Super durable material
2. Simple installation
3. Kit includes cams for both 2&4 strokes application

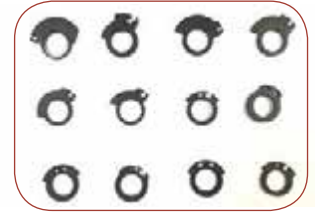

V-102ED
L135mm

V-101ED
L135mm

V-101
L120mm



V-102
L120mm
Double Density Material Gel/Kraton



CWG-M002
L120mm
Material Kraton/PVC



CWG-M002/S
L120mm
Material kraton/PVC



CWG-GM003/D

V-9720

- Universal 7/8" handle bar grip
- Available in NEW Vespa motorcycle



CWG-9505
L120mm
Material Alloy



CWG-20288
L125mm
Double Density Material Gel/kraton



CWG-100B
L130mm
Material Kraton/PVC



CWG-20289
L125mm
Double Density
Material Gel/kraton



CWG-30388
L130mm
Double Density
Material Gel/kraton



CWG-M001/3
L120mm
Double Density
Material Gel/kraton

MOTORCYCLE GRIP

Flame series

CWG-20588E

L135mm
PAT.



E



CWG-20588S

L135mm
PAT.



CWG-20588

L128mm
PAT.



CWG-20588

L128mm
PAT.



CWG-20588

L128mm
PAT.



CWG-20588

L128mm
PAT.

CWG-20588

L128mm
PAT.



GM001/002 PARTS



CWG-M001

L120mm
Double Density Material
Gel/Kraton



CWG-M002



CWG-M003/D



CWNE01



Anti-Slip Coil



Dust-Proof Foam



Anti-Slip Glue



V-105ED

L135mm
Material Alloy/Kraton



V-106ED

L135mm
Material Alloy/Kraton



V-107ED

L135mm
Material Alloy/Kraton



V-108ED

L135mm
Material Alloy
Kraton with LED



V-109G



V-109BK



V-109S



HEATED GRIP



NEW
Heated Grip
V-8706-M



NEW
Heated Pad



MOTORCYCLE GRIP

No. 58, Niourouliiao, Datong Village, Anding
District Tainan City, Taiwan R.O.C. 74558

TEL: 886-6-5939441

FAX: 886-6-5937343

<http://www.v-grip.com.tw/>

E-mail: vg@v-grip.com.tw
daylue@ms43.hinet.net

